

E. L. Foust Co., Inc.

P.O. Box 105, Elmhurst, IL 60126
1-800-353-6878 or (630) 834-4952
FAX (630) 834-5341
WEBSITE - www.foustco.com
E MAIL - sales@foustco.com

DENNYFOIL® ALUMINUM VAPOR BARRIER

Here's the finest reflective insulation and vapor barrier for your money. Meets all FHA requirements for vapor protection on floors, sidewalls, ceilings and linings between loose subfills and concrete. Dennyfoil Vapor barrier cuts mildew and dampness, reduces inner wall condensation, retards combustions. It is clean, light and easy to install.

ALWAYS USE DENNYFOIL VAPOR BARRIER ON WARM SIDE OF WALL

Tremendous in commercial use...

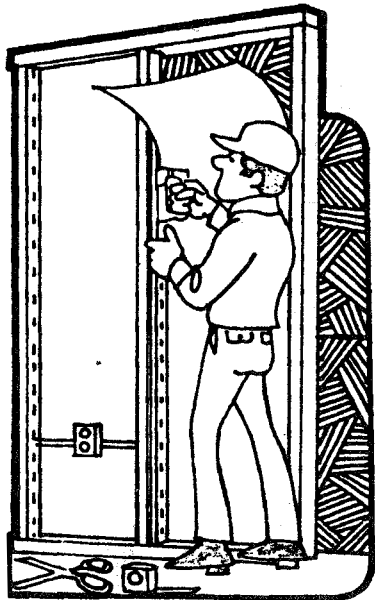

Factories, office building and retail establishments...
can save energy and reduce fuel costs with Dennyfoil. Quick, easy application to all types of walls, floors, roofs and ceilings makes it ideal for commercial use. And Dennyfoil is clean, light and economical.

- Ceilings & Floors – Save 50-60% Heat Loss
- Walls - Retain 50% More Heat
- Attics & Roofs – Summer Reduction of 20°
- Cupboards & Pantries – Stay Dry & Free From Moisture
- Radiators & Water Heaters – Operate More Efficiently

LOW COST - EASY TO APPLY

Dennyfoil Aluminum Insulation is installed with minimum equipment at low cost. Tools include knife or shears, stapler or tack hammer and rule. Professionals and non-professionals alike find directions easy to follow; application fast and clean.

Dennyfoil #245 - 500 sq. ft. ~~\$44.60~~ 49.53
3 ft. wide - 166½ ft. long

Mobile Homes

can be made more energy efficient with Dennyfoil. When installed between the sheathing and interior wall, Dennyfoil will act with two insulating air spaces to improve thermal resistance.

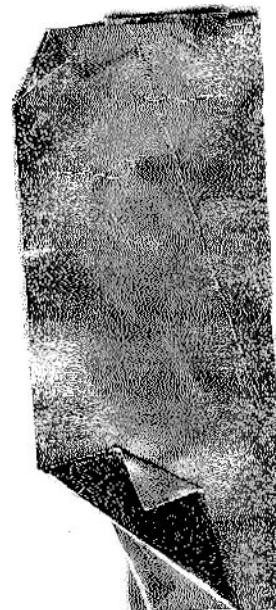
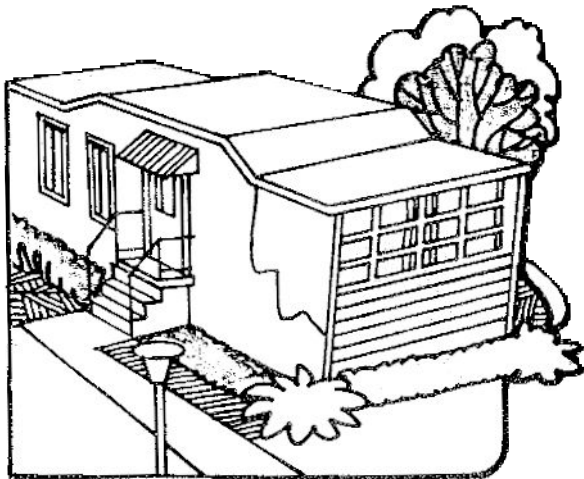

Great at home

Ceilings and floors...

are better insulative barriers when Dennyfoil is installed. You'll save 50% of heat loss through ceilings and 64% through floors with Dennyfoil. And that adds up to a big cash savings in light of today's rising energy costs.

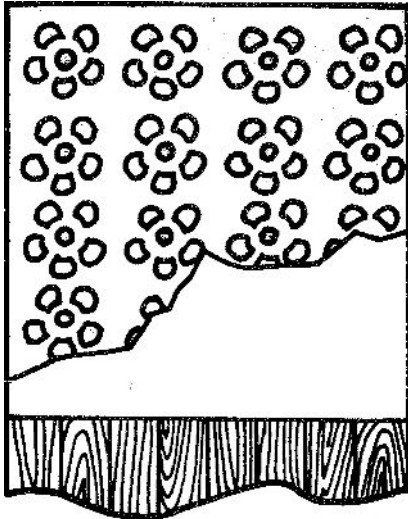

Walls...

will retain 50% more heat with Dennyfoil. And, Dennyfoil's vapor barrier reduces water condensation in the wall space to eliminate rotted sheathing, blistered paint and timber decay. Dennyfoil is also recommended for use with bulk wall insulation to prevent bulk material from absorbing moisture and becoming less effective.

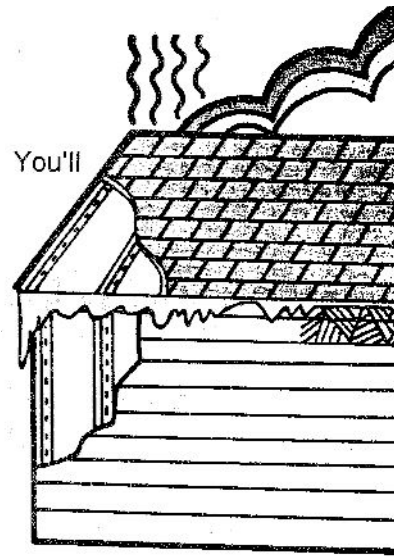

Attics and roofs...

help keep your home cool in the summer and warm in

the winter when Dennyfoil is applied. A summer temperature reduction of up to 20° can be obtained when Dennyfoil is stapled over the roof rafters in your attic.

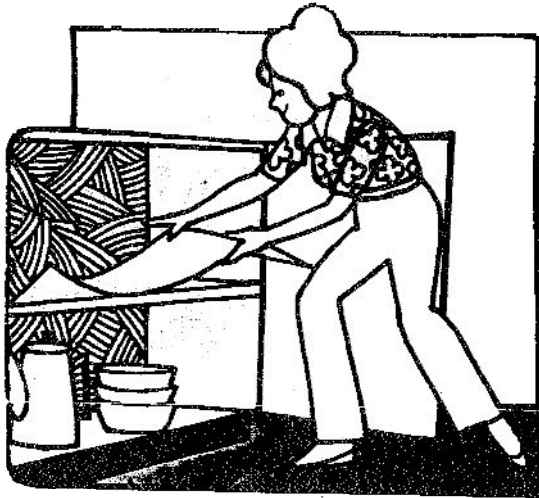
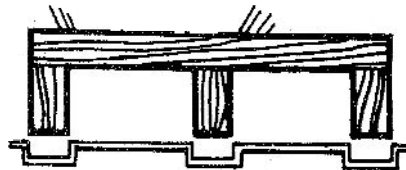

Cupboards and pantries...

Stay dry and free from moisture to avoid food spoilage when Dennyfoil is applied to shelves. Install Dennyfoil in closets and prevent dampness and mildew there, too.

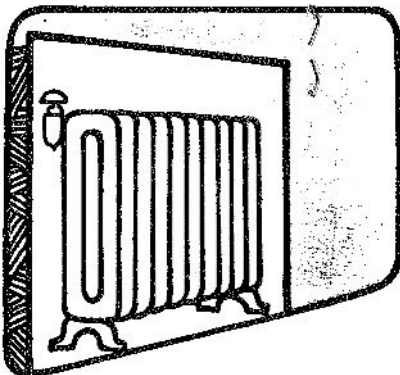
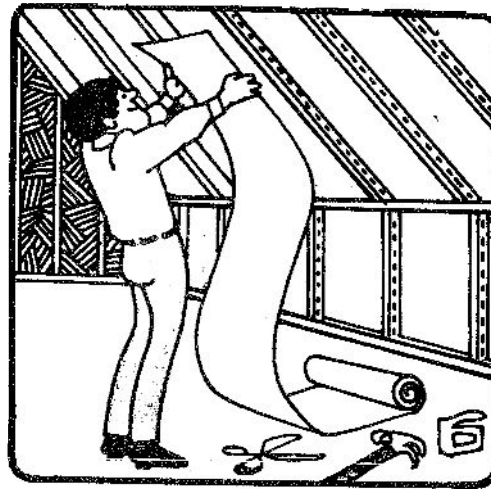

Radiators and water heaters...

Are more efficient when Dennyfoil is installed behind them. The aluminum surface reflects heat from radiators and water heaters back into your home - saving energy and money.

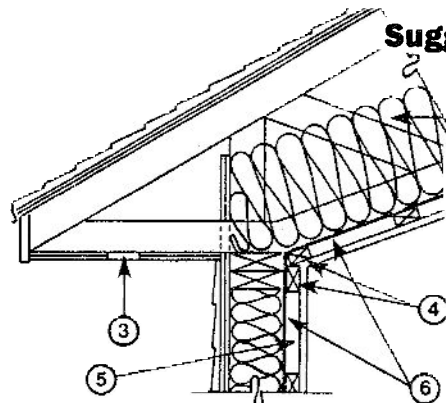

Suggested Application

- ② Specified Insulation
- ③ Soffit/Eave Vent
- ④ 1" x 2" Furring
- ⑤ 3/4" Air Space
- ⑥ Vapor Barrier